

RO*820X Piton-Fix / Piton-Fix

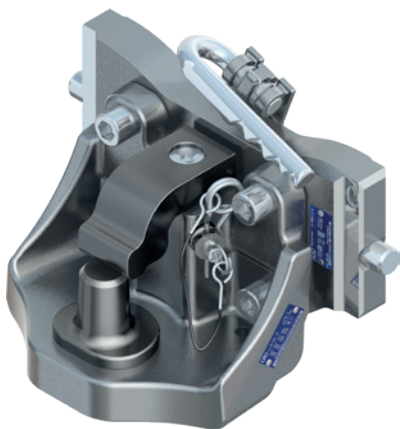

Vorteile auf einen Blick / Advantages at a glance

- DE** • Manueller Piton-Fix mit Fahrstuhllager
- EN** • Manual Piton-Fix with height-adjustable bearing

Kuppelbare Zugösen / Detachable towing eyes

DIN 9678

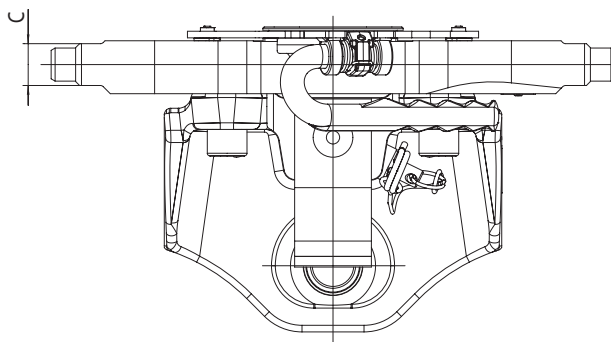
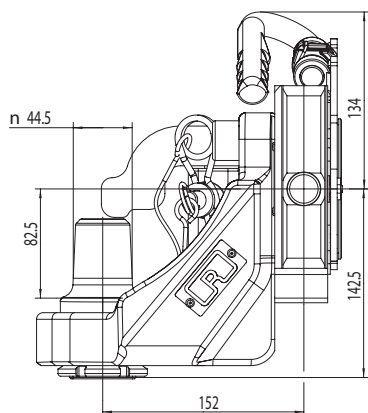
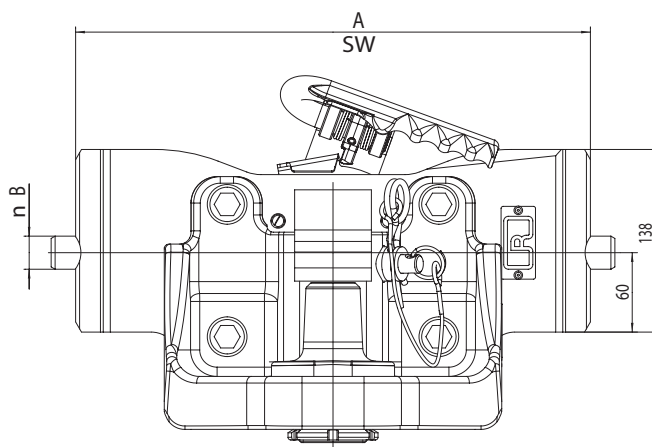

Auswahltabelle / Selection table

Artikel-Nr. / Order No.	Spurweite A,B,C /Track width A,B,C (mm)	S (t)	D (kN)	ABG (M)	EG (e1)
RO820X30000	330/25/32	3,0	89,3	✓	✓
RO820X30040 ¹	330/25/32	3,0	89,3	✓	✓
RO820X90000	390/25/32	3,0	98,1	✓	✓
RO820X90000 ¹	390/25/32	3,0	98,1	✓	✓

¹ John Deere grün/John Deere green

DE Technische Daten

Zapfen \varnothing 44,5 mm (ISO 6489-4)

EN Technical data

Pin \varnothing 44.5 mm (ISO 6489-4)